

# Aurelia S 45

Patrick Jouin, 2021

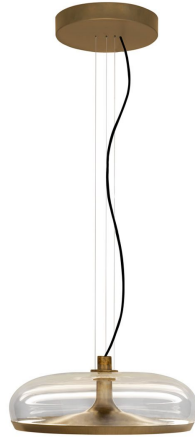

## Description

Collection of hand-blown glass pendants in transparent or smoke grey combined with a metal structure in hand finished vintage brass, matte gunmetal or glossy warm white. Two shapes/dimensions and six color combinations with matching canopy. Two integrated LED light sources (direct and indirect) with the ability to turn on/off/dim independently. Both LEDs are available in 2700K or 3000K and are user replaceable. Smart disassembly system to remove the glass diffuser for quick and easy cleaning.

## Product features

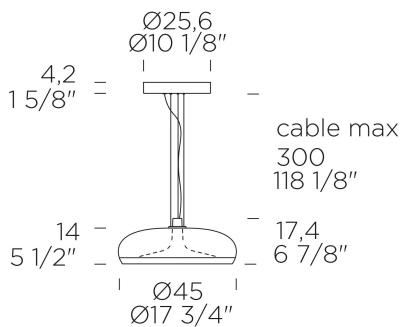

### Product code

0011467

### Structure finish

Pendant

### Environment

Indoor

### Materials

glass, metal

**Finitura diffusore**  
transparent

**Certifications**  
CE 

**Finitura struttura**  
vintage brass

**Protection degree**

IP 20

**Dimensions**

118in x 5in x 17in

**Net weight**

8kg

**Gross weight**

10,2kg

## Light source

---

### Standard

DIRECT LIGHT: LED 1 x 11,6W 1531 lm 3000K CRI?90 + INDIRECT LIGHT: LED 1 x 18W 1960 lm 3000K CRI?90 (dimmable: Push-dim; 0/1-10V. On request: phase cut dimmer and DALI).

## Product available also on these versions

---

**source** DIRECT LIGHT: LED 1 x 11,6W 1531 lm 3000K CRI?90 + INDIRECT LIGHT: LED 1 x 18W 1960 lm 3000K CRI?90 (dimmable: Push-dim; 0/1-10V. On request: phase cut dimmer and DALI). A++/A

### structure finish

 glossy warm white

 matte gunmetal

 vintage brass

 glossy warm white

 matte gunmetal

### diffuser finish

 smoke grey

 smoke grey

 smoke grey

 transparent

 transparent

### code

0011475

0011474

0011473

0011469

0011468

---

## Models

---



**Aurelia S 45**

Pendant



**Aurelia Bold S 22**

Pendant